



KING KOOKER

OUTDOOR COOKERS



CAST COOKER WITH TIMER ASSEMBLY INSTRUCTIONS AND USE AND CARE MANUAL

MODEL/SERIAL # _____

THE INSTRUCTION MANUAL CONTAINS IMPORTANT INFORMATION NECESSARY FOR THE PROPER ASSEMBLY AND SAFE USE OF THE APPLIANCE. READ AND FOLLOW ALL WARNINGS AND INSTRUCTIONS BEFORE ASSEMBLING AND USING THE APPLIANCE. FOLLOW ALL WARNINGS AND INSTRUCTIONS WHEN USING THE APPLIANCE. KEEP THIS MANUAL FOR FUTURE REFERENCE.

METAL FUSION, INC.

712 St. George Avenue.
Jefferson, LA 70121

If you have any problems or questions

Call Us Toll Free at

1-800-783-3885

7:30 AM to 3:30 P.M. CST • Monday through Friday

(504) 736-0201

www.kingkooker.com



▲WARNING

FAILURE TO FOLLOW THESE INSTRUCTIONS AND WARNINGS COULD RESULT IN FIRE, EXPLOSION, BURN HAZARD OR CARBON MONOXIDE POISONING WHICH COULD CAUSE PROPERTY DAMAGE, PERSONAL INJURY OR DEATH.

 **DANGER**

If you smell gas:

1. Shut off gas to the appliance.
2. Extinguish any open flame.
3. If odor continues, keep away from the appliance and immediately call your Fire Department.

FAILURE TO FOLLOW THESE INSTRUCTIONS COULD RESULT IN FIRE OR EXPLOSION WHICH COULD CAUSE PROPERTY DAMAGE, PERSONAL INJURY OR DEATH.

 **DANGER**

1. Never operate this appliance unattended.
2. Never operate this appliance within 10 feet (3.05m) of any structure, combustible material or other gas cylinder. Do not locate this appliance under ANY overhead construction.
3. Only use propane burning units outdoors. Risks include fire and carbon monoxide fumes. Lack of ventilation can cause injury or death.
4. Never operate this appliance within 25 feet (7.5 m) of any flammable liquids or vapors.
5. Do not fill cooking vessel beyond maximum fill line.
6. When cooking with oil/grease, always use the thermometer provided and never allow the oil/grease to get hotter than 350°F (177°C). If the temperature exceeds 350°F (177°C) or if oil begins to smoke, immediately turn the burner or gas supply OFF.
7. Heated liquids and equipment remain at scalding temperatures long after the cooking process. Never touch cooking appliance until liquids have cooled to 100°F (38°C) or less.
8. If a fire should occur, keep away from the appliance and immediately call your Fire Department. Do not attempt to extinguish an oil/grease fire with water. When cooking, have a Type BC or ABC fire extinguisher readily available. A Type BC or ABC fire extinguisher may, in some circumstances, contain the fire.

FAILURE TO FOLLOW THESE INSTRUCTIONS AND WARNINGS COULD RESULT IN FIRE, EXPLOSION, BURN HAZARD OR CARBON MONOXIDE POISONING WHICH COULD CAUSE PROPERTY DAMAGE, PERSONAL INJURY OR DEATH.

⚠ WARNING

READ AND UNDERSTAND BEFORE USING THIS PRODUCT

Throughout this manual the words appliance, cooker, fryer/boiler, burner and stove will be used interchangeably to refer to the King Kooker® Outdoor Cooker.

- 1) This is an **ATTENDED** appliance. The timer located on the hose/regulator is **NOT** a replacement for proper monitoring. Do **NOT** leave this appliance unattended while the burner is lit or while heating oil, grease, water, or cooking food.
- 2) **DO** monitor the oil temperature constantly using the thermometer provided with the cooker. Monitor the appliance when hot after use [oil, grease or water above 100°F (38°C)]. Heated liquid and equipment can remain at scalding temperatures long after cooking has ended.
- 3) **NEVER** overfill the cooking pot with oil, grease or water. Follow instructions in this manual for establishing proper oil, grease or water levels.
- 4) **DO NOT** light or relight burner if the oil level is not filled to the “Minimum Fill Line” level mark on the cooking pot.
- 5) Keep children, pets and unauthorized persons away from the appliance at all times.
- 6) The use of alcohol, prescription or non-prescription drugs may impair your ability to properly assemble or safely operate this appliance. Do **NOT** assemble or operate this appliance if using alcohol, prescription or non-prescription drugs.
- 7) This appliance is for **OUTDOOR** use only. Do **NOT** use in a building, garage, tent or any other enclosed area. Do **NOT** use in or on a recreational vehicle or boat. **NEVER** use this appliance as a heater.
- 8) Do not locate this appliance under **ANY** overhead construction. Keep a minimum clearance of 10ft. (3.05m) from the sides, front and back of the appliance to **ANY** construction. Keep the area clear of **ANY** combustible material. Do not use on or under **ANY** apartment or condo balcony or deck.
- 9) When cooking, the fryer/boiler must be on a level, stable, noncombustible surface such as brick, concrete or dirt. Not suitable are surfaces such as wood, asphalt or plastic which may burn, blister or melt.
- 10) Check all cooker fittings for leaks before each use. Do not use a flame to check for gas leaks. Keep the fuel supply hose away from any heated surfaces. Only the LP hose/regulator and timer assembly specified by Metal Fusion, Inc. should be used with this appliance.
- 11) When cooking with oil or grease, the thermometer provided **MUST** be used. Follow instructions in this manual for proper installation and use of thermometer. If the thermometer supplied with the fryer/boiler has been lost or damaged, a replacement thermometer specified by Metal Fusion, Inc. shall be obtained before using the appliance.
- 12) If the temperature of cooking oil exceeds 350°F (177°C) or if oil begins to smoke, immediately turn the burner or gas supply **OFF** and wait for the temperature to decrease to less than 350°F (177°C) before relighting burner according to the instructions in this manual.
- 13) When cooking with oil/grease, have a Type BC or ABC fire extinguisher readily available. In the event of an oil/grease fire, do not attempt to extinguish with water. Immediately call the Fire Department. A Type BC or ABC fire extinguisher may, in some circumstances, contain the fire.

- 14) Introduction of water or ice from any source into the oil/grease may cause overflow and severe burns from hot oil and water splatter. When frying with oil/grease, all food products **MUST** be completely thawed and towel dried before being immersed in the fryer.
- 15) Never drop food or accessories into hot cooking liquid. Lower food and accessories slowly into the cooking liquid in order to prevent splashing or overflow. When removing food from the appliance, care shall be taken to avoid burns from hot cooking liquids.
- 16) This appliance and pot, including handles and lids, gets dangerously hot in use. Use well-insulated pot holders or oven mitts for protection from hot surfaces or splatter from cooking liquids. Safety goggles are also recommended to protect you from oil splatter. The oil remains dangerously hot hours after use.
- 17) Do **NOT** place an empty cooking vessel on the appliance while in operation. Use caution when placing anything in the cooking vessel while the appliance is in operation. Never use a cooking vessel larger than the capacity and diameter specified in this manual.
- 18) In the event of rain, snow, hail, sleet or other forms of precipitation while cooking with oil/grease, cover the cooking vessel immediately and turn off the appliance burners and gas supply. Do not attempt to move the appliance or cooking vessel.
- 19) Do **NOT** move the appliance when in use. Allow the cooking vessel to cool to 100°F (38°C) before moving or storing.
- 20) Avoid bumping of or impact with the appliance to prevent contact with hot appliance, spillage or splashing of hot cooking liquid.
- 21) See Use and Care section for LP Gas Cylinder Information. A 20 pound (9 kg) cylinder should be used with this cooker. The LP-gas supply cylinder used must have a protective collar and must be constructed and marked in accordance with the specifications for LP-gas cylinders of the U. S. Department of Transportation (DOT) or the National Standard of Canada, *CAN/CSA-B339, Cylinders, Spheres and Tubes for the Transportation of Dangerous Goods*. Do not store a spare LP-gas cylinder under or near this appliance. Never fill the cylinder beyond 80% full. For proper vapor withdrawal, the 20 lb. (9 kg) cylinder should be used in the proper upright position. Cylinder must be turned off while not in use. Failure to follow these instructions and warnings could result in fire or explosion which could cause property damage, personal injury or death.
- 22) This appliance is not intended for commercial use.
- 23) Use King Kooker® appliances only in accordance with state and local ordinances, or in the absence of local codes, with the National Fuel Gas Code, *ANSIZ223.1/NFPA 54, Storage and Handling of Liquefied Petroleum Gases, ANSI/NFPA 58 or CSA B149.1, Natural Gas and Propane Installation Code*.

▲WARNING

FAILURE TO FOLLOW THESE INSTRUCTIONS AND WARNINGS COULD RESULT IN FIRE, EXPLOSION, BURN HAZARD OR CARBON MONOXIDE POISONING WHICH COULD CAUSE PROPERTY DAMAGE, PERSONAL INJURY OR DEATH.

**READ AND UNDERSTAND ALL INSTRUCTIONS BEFORE
USING YOUR KING KOOKER® PRODUCT**

TABLE OF CONTENTS

Warnings 2-4

Table of Contents 5

Warranty 6

Owners Registration 7-8

Introduction 9

 Battery Installation 10

 Battery Warning and Cautions 10

Section I - King Kooker® Outdoor Cooker Assembly 11

 Outdoor Cooker Assembly Instructions 11

 Hose Assembly Instructions 12

Section II - Use and Care 12

 Thermometer Instructions and Safety Precautions for Deep Frying with Outdoor Cookers 12-13

 Determining Proper Fill Levels for Cooking Vessels 13

 LP Gas Cylinder Information 13

 Connection Instructions 14

 Leak Test Instructions 14

 Placement Instructions 15

 Lighting and Operating Instructions 16-17

 Turning Off and Storing the Cooker after Use 18

 Maintenance Of Outdoor Cookers And Accessories 18-19

 Caring For Aluminum and Cast Iron Cookware 19

 Information Regarding Cooking Oil 19

Section III - Cooking Specialties 20

 Deep Fried Turkey Instructions 21

 Injecting Techniques 22

Section IV - Frequently Asked Questions 23

RECIPES

Congratulations on your purchase of your King Kooker® Outdoor Cooker. You will be delighted with the variety of dishes you can prepare with your cooker. Use your imagination and you can be a gourmet chef, surprising your friends and family with the wonderful meals you will prepare. We have provided a few recipes on our website - www.kingkooker.com - to get you started. There are a wide variety of seasonings/marinades available to experiment with and enjoy.

Cook with your King Kooker® and EAT LIKE A KING!

METAL FUSION, INC.

LIMITED ONE-YEAR WARRANTY

WHAT THIS WARRANTY COVERS

This warranty covers all components of this outdoor cooker to be free from defects in materials and workmanship, with the exceptions stated below.

HOW LONG COVERAGE LASTS

This warranty runs for one year from the date of purchase. Please keep your receipt with this manual for future reference.

WHAT IS NOT COVERED

This warranty does not cover the following:

Incidental and Consequential Damages. This warranty does **not** cover incidental and consequential damages arising in any way out of the use of this outdoor cooker. The liability of Metal Fusion, Inc. is, in any event, limited to the amount of the original purchase price of this outdoor cooker, and remains in force only as long as the product remains in its original, as-built configuration. Some states do not allow the exclusion or limitation of incidental or consequential damages, so the above limitation or exclusion may not apply to you.

Neglectful Operation. This warranty does **not** cover any loss or damage arising in any way due to the negligent operation of this outdoor cooker.

Altered, Repaired or Misused Equipment. This warranty does **not** cover any loss or damage arising in any way out of the use of this outdoor cooker when it has been altered, repaired by persons other than Metal Fusion, Inc., or when it has been abused or misused, or when it has been used other than in accordance with the manufacturer's operating instructions, including, without limitation, any damage to the consumer's pots because they were placed on a lit cooker while the pot is empty.

Other Assumed Responsibilities. Unless otherwise provided by law, this warranty does **not** cover any responsibility or liability arising in any way out of the use of this product where that responsibility or liability was purportedly assumed by any other person or agent.

Paint, Discoloration, Rust and Corrosion. This warranty does **not** cover the paint on the outdoor cooker, as in a normal use of the outdoor cooker, the paint will be burned off. Nor does this warranty cover discoloration, rust or corrosion to the cooker or LP hose/ regulator with timer assembly as these occurrences are part of the cooker's normal wear and tear.

WHAT METAL FUSION, INC. WILL DO

Metal Fusion, Inc. will repair or replace any outdoor cooker that proves to be defective in materials or workmanship. In the event repair is not possible or economically feasible, Metal Fusion, Inc. will replace your outdoor cooker with an identical or substantially equivalent outdoor cooker. Metal Fusion, Inc. will perform this service at no charge to you, except for the actual cost of shipping and handling the outdoor cooker or replacement parts.

HOW TO GET SERVICE

In the event you have a problem or malfunction with your outdoor cooker, simply call Metal Fusion, Inc. at (800) 783-3885.

HOW STATE LAW APPLIES

This warranty gives you specific rights, and you may have other rights which vary from state to state.

OWNER'S REGISTRATION



Dear Customer,

Thank you for purchasing a King Kooker®! Please take a moment to fill out your registration form and return it to us. We are always happy to hear suggestions and comments from our customers about our products. Completion of this registration allows us to contact you if the need arises. Please keep your receipt with your instruction manual. It will be necessary as a proof of purchase for us to help you if there is a problem with your cooker.

Name: _____

E-Mail: _____

Address: _____

Telephone: _____

Model# _____

Date of Purchase _____

Place of Purchase _____

Price Paid _____

Was this a gift _____ or did you _____ purchase it yourself?

Comments: _____

A SATISFIED CUSTOMER IS OUR MAIN GOAL. If you have any questions or problems, please call us at 1-800-783-3885 before returning the product to the point of purchase. Please have your receipt available when calling.

**THANK YOU,
ENJOY YOUR COOKING EXPERIENCE.**

TAPE HERE

FOLD



Place
Stamp
Here

METAL FUSION, INC.
712 St. George Avenue
Jefferson, LA 70121

FOLD

READ AND UNDERSTAND ALL INSTRUCTIONS BEFORE USING YOUR KING KOOKER® PRODUCT

INTRODUCTION

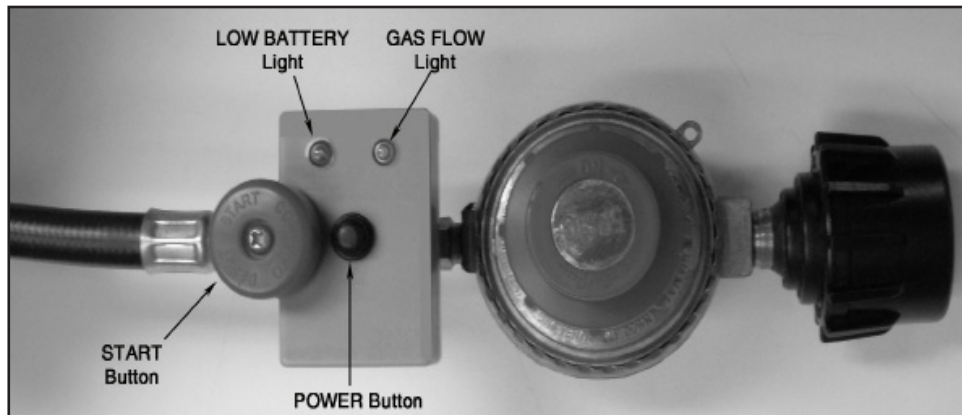

Your new King Kooker® Outdoor Cooker is equipped with a timer located on the hose/regulator (see above picture). The timer is designed to shut-off the flow of gas after a pre-set time period (approximately a 15 minute operational cycle) unless manually reset by the user. This timer and the supplied thermometer are not a substitute for attending a cooker. This timer/hose/regulator assembly should ONLY be used on this King Kooker® Outdoor Cooker with the pots provided containing oil or water in accordance with the instructions in this manual. Follow all instructions and warnings contained in this manual for proper assembly and use of this product.

IMPORTANT: The timer is NOT a replacement for proper monitoring and will not measure or control the temperature of the cooking liquid within the pot. Your cooker must always be attended while in use and monitored after use while still hot [100°F (38°C)]. The oil in the pot can overheat quickly if left unattended. The thermometer supplied with this appliance must always be used to monitor the temperature of the cooking liquid.

ATTENTION!

1. DO NOT light or relight burner if the oil level is not filled to the “Minimum Fill Line” level mark on the cooking pot.
2. DO NOT light or relight burner if the oil temperature is at or above 350° F (177° C) .
3. DO NOT leave this cooker unattended when cooking or when the oil temperature is above 100° F (38°C).
4. DO monitor the oil temperature constantly using the thermometer provided with the cooker.

▲WARNING

FAILURE TO FOLLOW THESE INSTRUCTIONS AND WARNINGS COULD RESULT IN FIRE, EXPLOSION, BURN HAZARD OR CARBON MONOXIDE POISONING WHICH COULD CAUSE PROPERTY DAMAGE, PERSONAL INJURY OR DEATH.

BATTERY INSTALLATION

**The timer requires two “AAA” alkaline batteries (not included) for operation.
Follow the below instructions for proper installation.**

1. Always disconnect regulator from the propane tank before installing or removing batteries.
2. Locate battery cover on timer. Press and slide battery cover off as shown.
3. Install two “AAA” alkaline batteries. Match positive (+) and negative (-) symbols located on the case and batteries to insure proper installation.
4. Replace the battery cover.
5. If the red “Low Battery” light becomes lit during use the batteries need to be replaced. Repeat the above steps to remove and replace batteries.

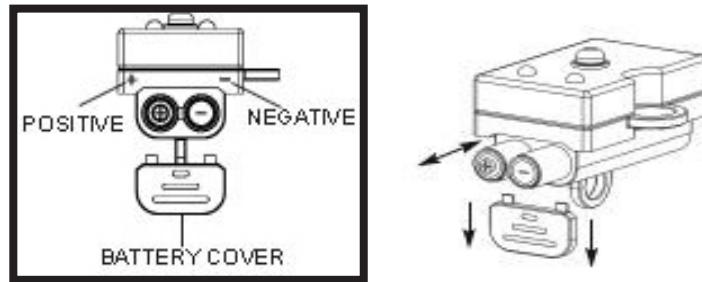

BATTERY WARNINGS AND CAUTIONS

1. Always read and follow the battery manufacturer’s instructions.
2. Keep batteries away from small children. If battery is swallowed consult a physician immediately.
3. Do not dispose of batteries in a fire. Dispose of batteries safely, following guidelines for your area.
4. Install batteries correctly according to the “Battery Installation” directions above. Improperly installed batteries may result in leaks and/or possible explosion.
5. Remove batteries from product after each use.
NOTE: Batteries which are not removed from this device will eventually corrode and leak and may cause the timer to malfunction. If the batteries were not removed and/or if the unit has been stored outdoors, test the timer for proper operation. Follow instruction number 4 on page 16 of this manual, **with the cylinder valve closed**. The green light (steady for 10 minutes and blinking for a further 5 minutes) will then go off showing that the timer is operating properly and you may proceed to use the cooker in accordance to the warnings and instructions in this manual.
6. Do not mix old and new batteries. Do not mix alkaline, standard or rechargeable batteries.

▲WARNING

FAILURE TO FOLLOW THESE INSTRUCTIONS AND WARNINGS COULD RESULT IN FIRE, EXPLOSION, BURN HAZARD OR CARBON MONOXIDE POISONING WHICH COULD CAUSE PROPERTY DAMAGE, PERSONAL INJURY OR DEATH.

SECTION I

OUTDOOR COOKER ASSEMBLY

⚠ WARNING

THE USE AND CARE MANUAL MUST BE READ AND UNDERSTOOD BEFORE USING THE APPLIANCE

Throughout this manual the words appliance, cooker, fryer/boiler, burner and stove will be used interchangeably to refer to the King Kooker® Outdoor Cooker.

TOOLS REQUIRED:

TORQUE WRENCH or ADJUSTABLE WRENCH, LEAK TESTING SOLUTION

1. Before assembling, check that all cooker components are included in the shipping carton. Identify these cooker parts from the assembly drawing. Accessories such as pots may vary according to model. Check the list of accessories on your cooker box. The following parts are considered essential and should be included in your package regardless of model number.

Required Parts List:

Cooker Stand, Cast Burner, LP Hose and Regulator with Timer, Thermometer

If any of the above parts are missing, contact Metal Fusion, Inc. at 1-800-783-3885 between the hours of 7:30 a.m. and 3:30 p.m. CST Monday through Friday for replacements.

2. Read assembly instructions, and understand sequence of assembly, before commencing to assemble your cooker.
3. If your casting(s) is not pre-installed follow the below **CASTING INSTALLATION** directions.
 - A) Remove top nut from casting bolt. Leave bottom nut attached and tightened (if applicable.)
 - B) Place the casting bolt through the hole on the flat bar casting support bracket as pictured below. The venturi tube of the burner should be located underneath the windshroud. For cookers supplied with a heat plate, place the heat plate onto the casting bolt beneath the flat bar casting support bracket.
 - C) Reinstall nut to casting bolt. Tighten. Check to see if casting is pointing straight up and is sturdy.

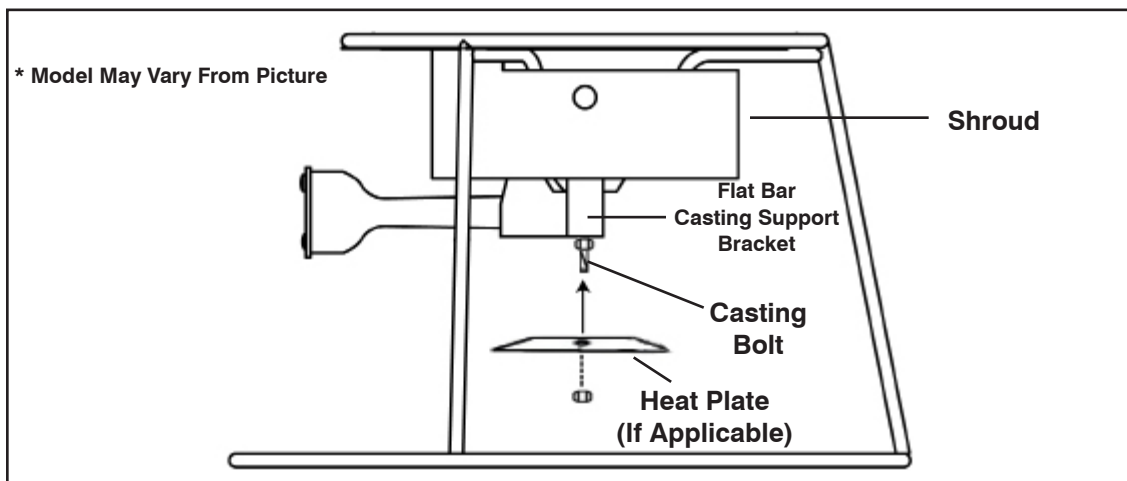
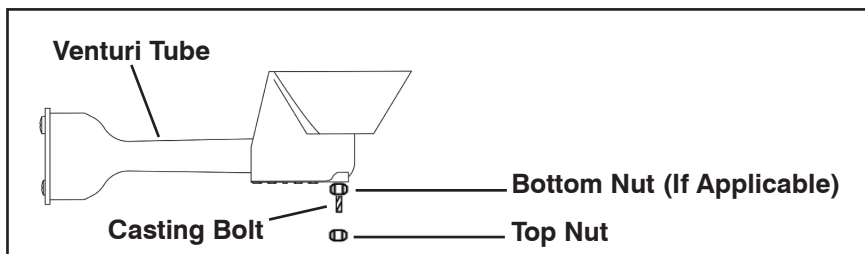

HOSE ASSEMBLY INSTRUCTIONS

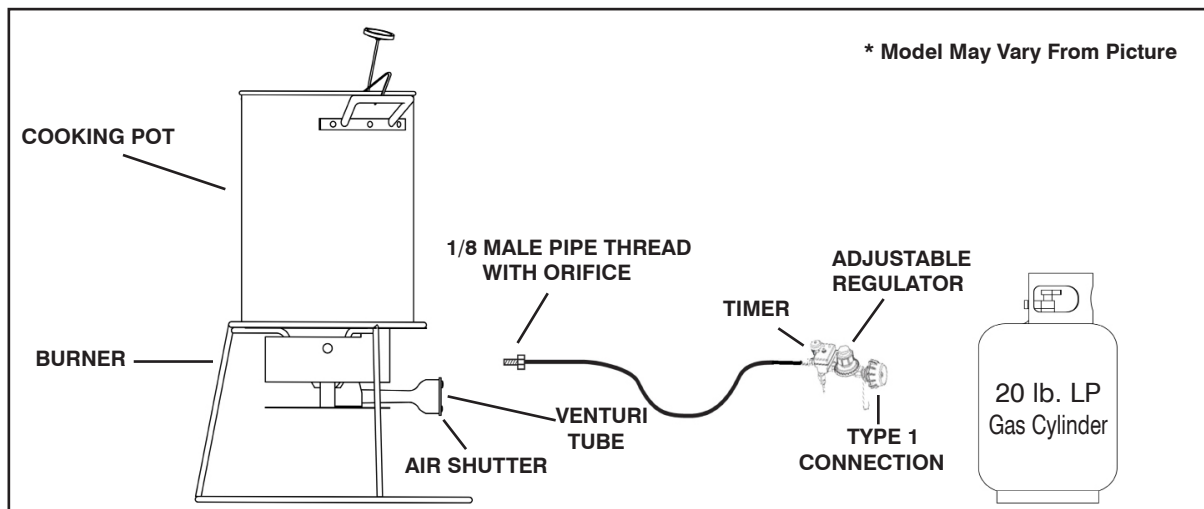

1. Tighten the hose fitting into the venturi with a torque wrench, up to a torque of 95 to 105 lb./in. Alternatively, hand tighten securely and then, using a wrench, tighten an additional 1-1 1/2 turns.
2. Go to the **Use and Care** section for further instructions.

SECTION II USE AND CARE

Throughout this manual the words appliance, cooker, fryer/boiler, burner and stove will be used interchangeably to refer to the King Kooker® Outdoor Cooker.

WARNING

**READ AND UNDERSTAND BEFORE USING THIS APPLIANCE
FAILURE TO FOLLOW THESE INSTRUCTIONS AND WARNINGS COULD RESULT IN FIRE,
EXPLOSION, BURN HAZARD OR CARBON MONOXIDE POISONING WHICH COULD CAUSE
PROPERTY DAMAGE, PERSONAL INJURY OR DEATH.**

THERMOMETER INSTRUCTIONS AND SAFETY PRECAUTIONS FOR DEEP FRYING WITH OUTDOOR COOKERS

1. Always use a deep fry thermometer when using this appliance as a fryer/boiler.
 - a. Before each use of the appliance make sure that the thermometer is properly calibrated by placing the tip in a pot of boiling water. The thermometer should register within +/-20° of 212°F or +/-10° of 100°C. If the thermometer is miscalibrated, contact Metal Fusion, Inc. to obtain a replacement before using the appliance.
 - b. Hang the thermometer on the inside of the pot with the probe immersed in the cooking liquid. Never place a lid over a pot when monitoring the temperature of oil.
 - c. Once the fire has been lit monitor the temperature on the thermometer at all times. Water boils at 212°F(100°C). The temperature of hot oil should never be allowed to exceed 350°F(177°C).

IMPORTANT: Oil can ignite at high temperatures. Most King Kooker® thermometers have a Red Zone above 350°F(177°C) to signify Danger. Never allow the temperature to exceed 350°F(177°C). If the temperature goes above 350°F(177°C) immediately turn the burner and gas supply OFF and wait for the temperature to decrease to below 350°F(177°C) before relighting according to instructions in the manual. If at any point during the cooking process the oil begins to smoke, immediately turn the burner and gas supply OFF regardless of the reading on the thermometer. Allow time for the oil to cool, then contact Metal Fusion, Inc. for further instructions.

- d. When the cooking is complete and the cooker has been turned off, allow the temperature of the oil to fall below 100°F(38°C) before moving the pot, cooking oil, or cooker.
- e. Please call Metal Fusion, Inc. at (800) 783-3885 with any questions concerning the use or operation of the thermometer.

2. Never cover the pot when cooking with oil.
3. Always thaw and dry food completely before placing it into hot oil. Frozen or wet food may cause oil or grease to overflow.
4. Never put an empty pot over an open flame.
5. In the event of rain, snow, hail, sleet or other forms of precipitation while cooking with oil/grease, cover the cooking vessel immediately and turn off the appliance burners and gas supply. Do not attempt to move the appliance or cooking vessel.
6. When cooking with oil or grease, fire extinguishing materials shall be readily accessible. In the event of an oil or grease fire do NOT attempt to extinguish with water. Immediately call your Fire Department. A Type BC or Type ABC fire extinguisher may, in some circumstances, contain the fire.

DETERMINING PROPER FILL LEVELS FOR COOKING VESSELS

Your turkey cooker includes a pot which has been stamped with a line or lines which indicate the level to which the oil should be filled for cooking. These lines are labelled on the pot. Fill the pot with oil to the appropriate level before lighting the cooker or adding food. Never overfill the cooking vessel with oil, grease or water. Never fill a pot beyond the maximum fill line. Always fill to at least the minimum fill line when cooking with oil. Some models of turkey cookers include pots with only one fill line. This indicates the exact level to which the oil should be filled before it is heated and food is added.

29 - 30 Quart Pot - Up To A 20 Pound Turkey

LP GAS CYLINDER INFORMATION

King Kooker® Outdoor Cookers are manufactured for use with **20lb. (9 kg) LP Gas Cylinders**. Important information to remember about LP Gas cylinders include:

1. Always read and follow the cylinder manufacturer's instructions.
2. Make sure that the gas cylinder is not overfilled. The maximum weight of a properly filled 20 lb. (9 kg) LP gas cylinder is approximately 38 lbs (17 kg). Never fill the cylinder beyond 80% full.
3. Make sure that the cylinder valve has the proper connection for a Type 1 appliance fitting.
4. Do not store a spare LP gas cylinder under or near this appliance.
5. Disconnect the cylinder from the cooker for storage.
6. Store the cylinder out of the reach of children.
7. Do not use or store the cylinder in a building, garage or enclosed area.
8. Always use a 20 lb. (9 kg) cylinder in the proper upright position for the proper vapor withdrawal. It should also be stored and transported in the upright position.
9. The cylinder must have a protective collar to protect the cylinder valve.
10. Place dust cap on cylinder valve outlet whenever the cylinder is not in use. Only install the type of dust cap on the cylinder valve outlet that is provided with the cylinder valve. Other types of caps or plugs may result in leakage of propane.
11. Cylinder must be turned OFF while not in use.

▲WARNING

ALWAYS READ AND FOLLOW THESE AND THE CYLINDER MANUFACTURER'S INSTRUCTIONS. FAILURE TO FOLLOW THESE INSTRUCTIONS AND WARNINGS COULD RESULT IN FIRE, EXPLOSION, BURN HAZARD OR CARBON MONOXIDE POISONING WHICH COULD CAUSE PROPERTY DAMAGE, PERSONAL INJURY OR DEATH.

CONNECTION INSTRUCTIONS

1. Check that your hose assembly is set to not allow gas flow. Turn the regulator control counterclockwise until it stops. This is the OFF position.
2. Attach the regulator to the cylinder valve by turning the Type 1 fitting clockwise. Hand tighten with the regulator positioned upright. Refer to the assembly diagram for the appliance below.

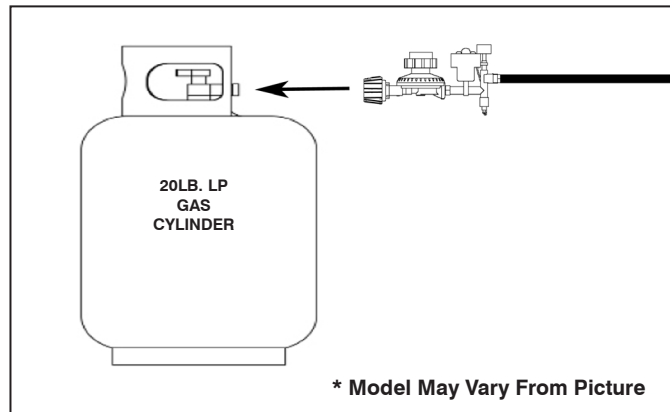

3. Perform the Leak Test:

LEAK TEST

Before lighting the appliance, a thorough leak test must be satisfactorily completed using a non-ammonia soapy water solution (50% non-ammonia soap and 50% water). This is to be applied with a small brush to all gas joints after the cylinder valve is opened (no more than 1/2 turn). If bubbles are seen, indicating a leak, turn off the cylinder and tighten the leaking connection until a further leak test shows no leaks.

If tightening the connection does not stop the leak, call Metal Fusion, Inc. (800) 783-3885, for assistance.

NEVER USE HOSE/REGULATOR ASSEMBLY IF LEAKING.

4. Before lighting the cooker, check that the venturi tube is free of obstruction and that the orifice is properly threaded into the venturi tube as per the hose connection instructions on pg. 12. Both situations must be corrected if necessary before lighting to prevent flashback.

PLACEMENT INSTRUCTIONS

1. Never operate this appliance within 10 feet (3.05m) of any structure, combustible material or other gas cylinder. Never operate this appliance within 25 feet (7.5m) of any flammable liquids or vapors.
2. There must be no combustibles or roof overhead.
3. Keep 24" (.61m) of space between the LP gas cylinder and the appliance.
4. The LP gas cylinder and appliance must be located so that any wind is blowing the heat of the appliance away from the propane cylinder. This also helps fire prevention by blowing the flames of a grease fire away from the propane cylinder.
5. Center the pot over the burner on the cooker. Do NOT use any pot larger than the recommended size for your cooker as listed below:

Maximum Pot Size
30 qt. (28.4 L) pot

Pot - Height/Diameter
16"x12 3/8" (40.6 cm X 31.5 cm)

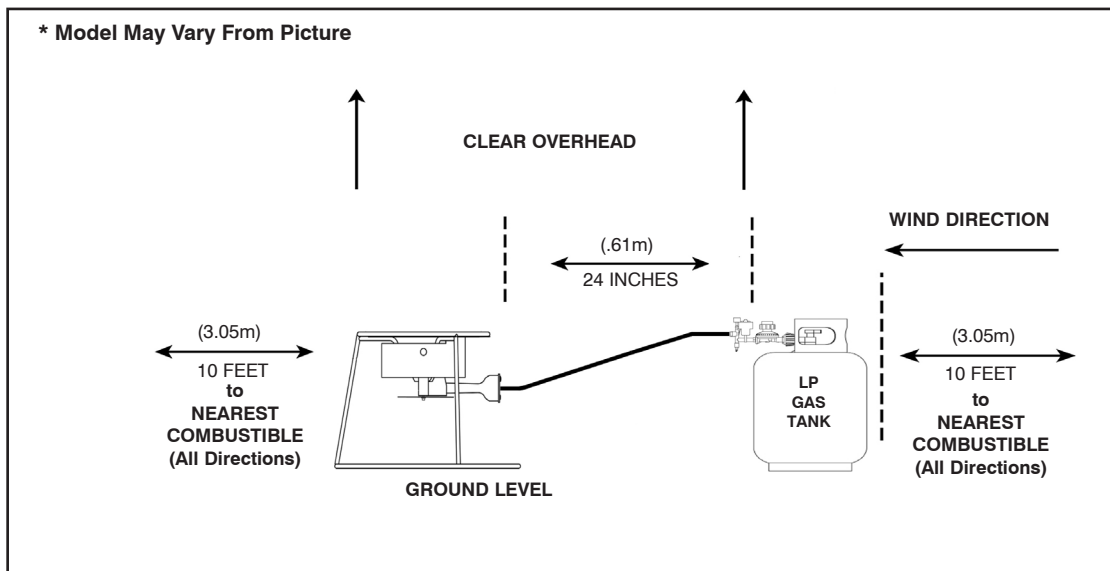

⚠️ WARNING!

Keep twenty-four inches between the cylinder and the appliance. Placing the cylinder too close to the appliance could result in fire or explosion which could cause property damage, personal injury or death.

The hose connecting the appliance to the tank poses a trip hazard. Do not step over the hose or walk between the cylinder and appliance. Tripping could cause the appliance or cylinder to tip over, leading to fire or explosion which could cause property damage, personal injury or death.

LIGHTING AND OPERATING INSTRUCTIONS

▲WARNING

THE COOKER MUST NOT BE LIT UNTIL THE PRECEDING PLACEMENT INSTRUCTIONS HAVE BEEN COMPLETELY FOLLOWED.

(ILLUSTRATIONS PAGE 17)

1. Check the casting to make sure it is set up as per the illustration (**Figure 1**).
 2. Make certain that the regulator control is turned to OFF by turning it counterclockwise until it reaches the stop.
 3. Open cylinder control valve by turning it counterclockwise as per the diagram (**Figure 2**).
 4. To start timer operation, push the black “POWER” button. Both lights will blink once. Press red “START” button. The green light will remain on. The timer is now set for a 15 minute operational cycle. Gas will not flow to the burner unless the timer is turned on.
 5. Insert a multipurpose lighter through the hole in the shroud as per **Figure 3**, or use a paper book match placed above the casting as per **Figure 4**. Turn the regulator control toward the “ON” position until ignition occurs. Turning the regulator control clockwise increases the gas pressure to the burner and hence the flame size (**Figure 2**).
When lighting the stove, if ignition does not occur in 3 to 5 seconds, turn the regulator and cylinder valve off. Wait 5 minutes for gas to disperse. Repeat procedure.
 6. Check that the flame is blue and that the flames are emitted from every port in the casting. If not, rotate the air shutter position until there is a blue flame. Opening the shutter too much will cause the flame to “Lift” off the burner (**Figure 5**).
If there is a yellow flame, or if some ports have no flame, this indicates there may be an obstruction in the venturi tube or ports. Check the maintenance instructions on page 18 for more information regarding a yellow flame.
 7. Always monitor the flame throughout the cooking process. If at any point in the cooking process the flame is accidentally extinguished, immediately turn the regulator and cylinder valve OFF. Wait 5 minutes for gas to disperse and relight the cooker according to the directions in this section.
 8. The timer will run 15 minutes before shutting off gas flow. The timer can be reset manually throughout the cooking process without shutting off the gas flow by pressing the red “START” button. This will start a new 15 minute operational cycle. At 5 minutes remaining in an operational cycle, the gas flow light (green) will blink slowly. At 2 minutes remaining in an operational cycle, the gas flow light (green) will blink quickly. If the timer completes a 15 minute cycle without being reset (pressing red “START” button), the gas flow will be turned off and the flame extinguished. If additional cooking is required, relight the cooker according to the directions in this section.
- IMPORTANT: The timer does not measure temperature and will not control the temperature of the cooking liquid within the pot. The temperature must be controlled manually by observing the thermometer and adjusting the flame with the regulator control knob (turn counterclockwise to reduce the flame, clockwise to increase the flame.) NEVER reset the timer without first reading the thermometer temperature.**
9. DO NOT manually reset the timer if the oil temperature reaches 350°F(177°C). If the temperature goes above 350°F(177°C) immediately turn the burner and gas supply OFF and wait for the temperature to decrease to below 350°F(177°C) before relighting according to instructions in the manual. If at any point during the cooking process the oil begins to smoke, immediately turn the burner and gas supply OFF regardless of the reading on the thermometer. Allow time for the oil to cool, then contact Metal Fusion, Inc. for further instructions.

The timer is NOT a replacement for proper monitoring and will not measure or control the temperature of the cooking liquid within the pot. Your cooker must always be attended while in use and monitored after use while still hot [100°F (38°C)]. The oil in the pot can overheat quickly if left unattended. The thermometer supplied with this appliance must always be used to monitor the temperature of the cooking liquid.

LIGHTING AND OPERATING INSTRUCTIONS (continued)

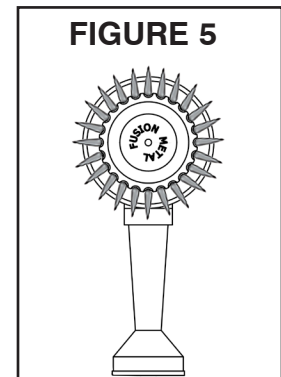
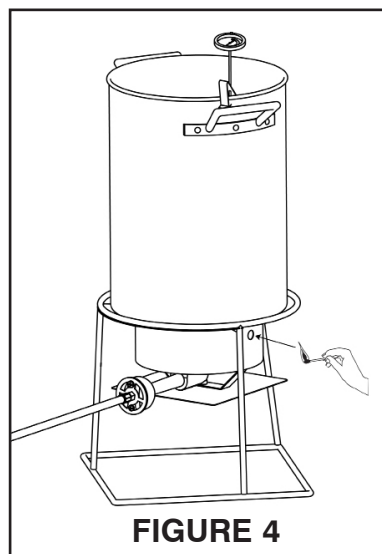
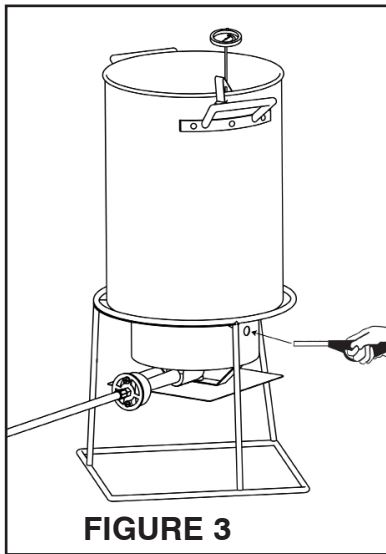
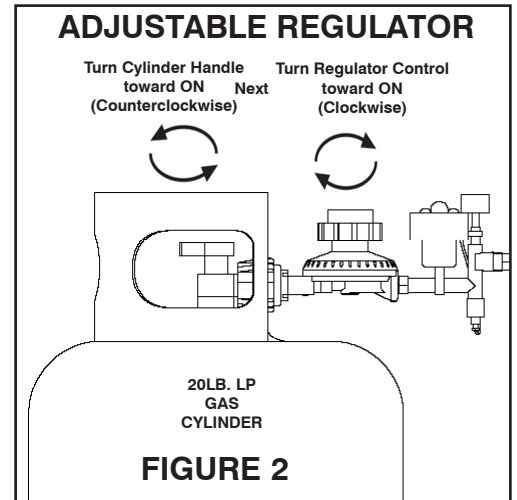
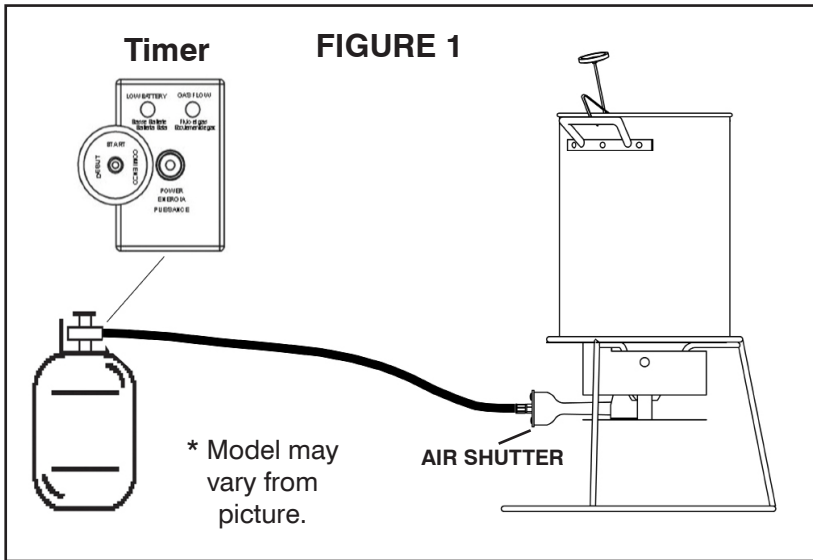

⚠ WARNING

NEVER PUT HANDS OR FACE DIRECTLY OVER BURNER WHILE LIGHTING OR WHILE THE APPLIANCE IS LIT.

TURNING OFF AND STORING THE COOKER AFTER USE

⚠WARNING

NEVER MOVE THE COOKER OR POT WHILE IN USE OR STILL HOT [ABOVE 100°F (38°C)].

1. After each use turn OFF the King Kooker® at the regulator first, then at the gas cylinder valve. **Check to make sure there is no flame and all valves are off.** Do not leave the cooker until it has cooled completely. When removing food from the cooker wear protective mitts.
2. Disconnect the regulator from the cylinder by turning the Type 1 fitting counterclockwise until the regulator is separated from the tank. Remove batteries from timer housing to avoid corrosion in storage.
3. Storage of this cooker indoors is permissible only if the cylinder is disconnected and removed from the cooker. Do not use or store cylinder in a building, garage or enclosed area. Read and follow all cylinder manufacturer's instructions. The cylinder must be stored out of the reach of children at all times. Keep entire unit in area to avoid insects and contamination that can clog the venturi tube.

⚠WARNING

FAILURE TO FOLLOW THESE INSTRUCTIONS AND WARNINGS COULD RESULT IN FIRE, EXPLOSION, BURN HAZARD OR CARBON MONOXIDE POISONING WHICH COULD CAUSE PROPERTY DAMAGE, PERSONAL INJURY OR DEATH.

MAINTENANCE OF OUTDOOR COOKERS AND ACCESSORIES

1. The area where the cooker will be used must be kept clear and free from combustible materials, gasoline and other flammable vapors and liquids. Before each use of the cooker inspect and remove any combustible items.
2. The flow of combustion and ventilation of air must not be obstructed. The cooker must be set in an open area with 10 ft. (3.05m) of space on all sides and no roof or overhang overhead. Check the location and placement of the cooker before each use.
3. Before each use of the appliance check the burner/venturi tube for insects, insect nests, and other obstructions. A clogged tube can lead to a fire beneath the appliance.
4. Follow all Lighting Instructions in the Use and Care Manual each time the cooker is used. Check the flame for proper color and appearance. The flame should burn with a primarily blue color. If a strong yellow flame is present, this could indicate an obstruction in the burner/venturi tube. If there is any obstruction or a yellow flame, and the air shutter adjustment has not solved the problem, turn off the cooker and allow time for it to cool. Disconnect the hose from the cooker. Remove the air shutter using a phillips head screwdriver. Check the venturi tube with a flashlight to see if there is a blockage. If a blockage is present use a wire such as a coat hanger to slide into the venturi tube to remove the blockage. Reattach the air shutter to the venturi tube using the phillips screwdriver. Assemble and light the cooker again as per the instruction manual. If this does not resolve the problem, please call Metal Fusion, Inc. at (800) 783-3885.
5. Always use the LP hose/regulator and timer assembly supplied with the appliance. Before each use of the appliance check the LP hose for evidence of abrasion, wear, cuts or leaks. If there is any damage to the hose, the hose/regulator and timer assembly must be replaced prior to using the appliance. Contact Metal Fusion, Inc. at (800) 783-3885 for information regarding a replacement hose assembly. Only the LP hose/regulator and timer assembly specified by Metal Fusion, Inc. should be used with the appliance.
6. For purchase of any replacement parts which may have become damaged or lost, please contact Metal Fusion, Inc. at (800) 783-3885 between the hours of 7:30am-3:30pm (CST) Monday through Friday.

7. Cleaning of the appliance:

Cooker Frame, LP Hose/Regulator and Timer: If necessary, remove any oil or liquid which has spilled onto the unit during cooking with mild soapy water on a rag and towel dry. Do not let water enter or collect in housing of timer. Do not immerse the burner unit or hose/regulator as this will cause rust and damage components of the timer.

Aluminum or Stainless Steel Pots: Clean after each use according to the directions below.

Cast Iron Cookware: Clean after each use according to the directions below.

Thermometer: Clean after each use with mild soapy water and towel dry. Do not submerge in liquid or put in dishwasher.

TIPS FOR CARING FOR ALUMINUM FRY PANS AND BOILING POTS

It is not necessary to season aluminum pots before cooking with them. Wash with a liquid dish washing detergent and towel dry.

After cooking, wash aluminum pots and fry pans in hot, sudsy detergent. If grease or black soot has cooked to the outside of the pot while cooking with your outdoor cooker, scrub the outside of the pot with a steel wool scouring pad.

DO NOT SPRAY OVEN CLEANER ON ALUMINUM POTS TO REMOVE GREASE OR SOOT. OVEN CLEANER WILL CAUSE THE FINISH TO BECOME DULL.

If food remains stuck in the pan after cooking, add hot water and let soak. Then scrub the pan with soap and steel wool to loosen the food.

If hard water causes darkening on the interior of your pot, fill to the level of the darkened area with a water and cream of tartar or vinegar solution (mixed with the concentration of three cups of water to one tablespoon cream of tartar, or vinegar). Boil five to ten minutes.

NEVER PLACE AN EMPTY ALUMINUM OR STAINLESS STEEL POT ON A LIT COOKER. A hole will be burned in the bottom of the pot. Discoloration, scratching, and dimpling may occur with the use of pots on outdoor cookers. This does not affect the performance of the pot.

Do not store used oil inside your aluminum pot. The salt used in cooking can corrode the pot causing the pot to leak. Wash the pot after each use with hot, soapy water and rinse.

SEASONING & CARE OF CAST IRON COOKWARE

New Cast Iron Pots are coated with paraffin to prevent rusting. Before using for the first time, wash with mild soapy water, rinse, and dry thoroughly. Never use abrasive detergents. Grease the entire surface of the cookware with a thin coating of solid vegetable shortening. Do not use salted fat (margarine or butter). Heat for 30-60 minutes in oven at 300-350°F (149-177°C). Remove from oven, pour out excess grease, and wipe with a paper towel. This completes the seasoning process. Each time the cast iron is used, coat the entire surface with a thin coat of solid vegetable shortening, wipe with a paper towel, and store.

INFORMATION REGARDING COOKING OIL

In our instructions we suggest peanut oil for deep frying. While this is an excellent choice, any good liquid vegetable oil may be substituted.

SUGGESTIONS FOR KEEPING USED COOKING OIL:

After initial use, let the oil cool. While slightly warm, filter out particles before storing in original container or similar sturdy plastic or glass container. This can be accomplished by using filter paper (coffee filters) or a clean cloth (dishtowel). Never pour hot oil into a container. For best results store oil in a cool place. It can be reused within 30 days. Discard after second use or when the flavor of reheated oil becomes objectionable to taste.

Helpful Hint: Try frying a batch of french fried potatoes after frying your turkey, chicken or fish. This aids in improving the flavor of the oil for the next use.

SECTION III

COOKING SPECIALTIES

⚠WARNING

The following warnings and directions apply particularly to cooking with oil and deep frying. Read ALL of the warnings and directions in the manual before using your cooker.

DEEP FRYING

COOKING WITH OIL IS NOT SIMILAR TO ANY OTHER COOKING METHOD.
Cooking oil is very combustible at high temperatures, and special precautions must be taken to avoid a dangerous grease fire.

1. Use the products only outdoors, and only on a level, stable, noncombustible surface such as brick, concrete, or dirt. **NOT SUITABLE** are surfaces such as wood, asphalt, or plastic which may burn, blister or melt. Keep clear from all combustible materials.
2. **DO NOT** use under any overhangs or roofs, and keep a minimum clearance of 10 ft. (3.05m) on all sides of the cooker. Keep the area clear of any combustible material. Do not use on or under any apartment or condo balcony or deck.
3. **DO NOT** leave unattended while cooker is in use or is still hot [above 100°F (38°C)].
4. Check all cooker fittings for leaks before each use. Keep the fuel supply hose away from any heated surfaces. Only the LP hose/regulator and timer assembly specified by Metal Fusion, Inc. should be used with this appliance.
5. When cooking with oil/grease, have a Type BC or ABC fire extinguisher readily available. In the event of an oil/grease fire do not attempt to extinguish with water. Immediately call the Fire Department. A type BC or ABC fire extinguisher may, in some circumstances, contain the fire.
6. **NEVER** overfill the cooking pot with oil, grease or water. Follow instructions in this manual for establishing proper oil, grease or water levels, (page 13).
7. Failure to completely thaw and dry food may cause oil or grease to overflow. When frying with oil or grease, all food products must be completely thawed and towel dried to remove excess water. Follow all instructions in this manual for frying foods.
8. When lowering and raising the turkey, always wear protective mitts and use extreme caution not to splash hot oil. Make sure the burner is off before lifting the turkey rack or before lifting the basket to drain.
9. **NEVER** allow grease temperature to exceed 350°F (177°C).
10. Follow **ALL INSTRUCTIONS** in this instruction manual for using your outdoor cooker.

DEEP FRIED TURKEY INSTRUCTIONS

ONLY PROCEED TO PREPARE YOUR TURKEY FOR FRYING IF YOU HAVE READ ALL THE INSTRUCTIONS IN THIS MANUAL

1. Check pg. 13, “**Determining Proper Fill Levels for Cooking Vessels,**” to determine the amount of oil and size of turkey recommended for your turkey cooker model. Tip: Make sure the meat of the entire bird is submerged, but the tips of the turkey leg bones can be above the level of the grease when the bird has been placed into the pot for cooking. This helps prevent overflow of the oil.
2. Pour the necessary amount of cooking oil into the pot. Never overfill the cooking vessel.
3. Light the cooker as per the instruction manual. Never allow temperature of oil to exceed 350°F (177°C). **Always** use a deep fry thermometer to monitor the temperature of the oil. **Never leave the cooker unattended!**

IMPORTANT: The timer does not measure temperature and will not control the temperature of the cooking liquid within the pot. The temperature must be controlled manually by observing the thermometer and adjusting the flame with the regulator control knob (turn counterclockwise to reduce the flame, clockwise to increase the flame.) NEVER reset the timer without first reading the thermometer temperature.

4. Thaw and towel dry the turkey completely. Coat the turkey inside and out with King Kooker® Cajun Seasoning. Inject with marinade if desired. See the following page for injecting tips.
5. Place the turkey on the frying rack or basket with the legs up (**Figure #1**).
6. Wearing mitts for protection and using the lifting hook or basket, lower the turkey into the 350°F (177°C) oil very slowly. Be careful not to splash hot oil. (**Figure #2**)
7. Cook turkey at 350°F (177°C) for 3 1/2 minutes per pound. When the planned cooking time has passed and it is time to check for doneness, turn the gas to the burner completely off. (**Figure #3**)
8. Make sure the burner is off before lifting the turkey to drain. Using mitts and lifting hook/basket again, **slowly** lift turkey from the pot. Allow the turkey to drain. Slice at the thigh joint. If the thigh appears to be well cooked, the turkey is ready. Allow the turkey to cool before slicing.

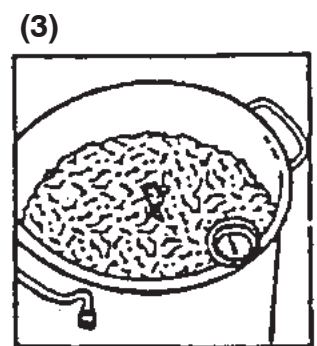
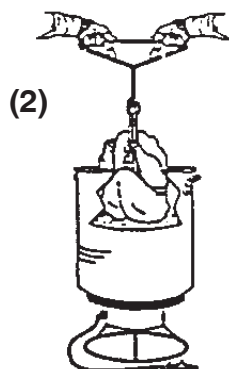
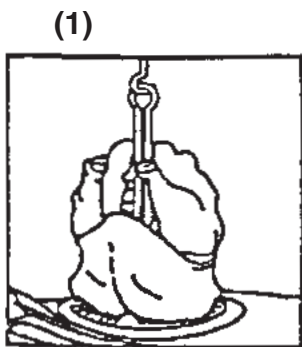

The timer is NOT a replacement for proper monitoring and will not measure or control the temperature of the cooking liquid within the pot. Your cooker must always be attended while in use and monitored after use while still hot [100°F (38°C)]. The oil in the pot can overheat quickly if left unattended. The thermometer supplied with this appliance must always be used to monitor the temperature of the cooking liquid.

⚠ WARNING

FAILURE TO FOLLOW THESE INSTRUCTIONS AND WARNINGS COULD RESULT IN FIRE, EXPLOSION, BURN HAZARD OR CARBON MONOXIDE POISONING WHICH COULD CAUSE PROPERTY DAMAGE, PERSONAL INJURY OR DEATH.

INJECTING TECHNIQUES FOR TURKEY, CHICKEN AND ROAST

IMPORTANT:
BEFORE INJECTING, POUR MARINADE INTO A SEPARATE CONTAINER TO KEEP FROM CONTAMINATING MARINADE.

CHICKEN

BAKED

1. Remove giblets and rinse chicken with warm water, drain cavity completely.
2. Fill Injector with desired amount of marinade.
3. Inject FULL amounts of marinade (approximately 1 oz.) at the indicated points, (breast, thigh, leg). Inject marinade slowly while pulling needle out of meat. This gives even distribution of seasoning. (For best results, insert needle at different angles through the same hole when injecting marinade.)
4. Sprinkle outside of chicken generously with King Kooker® Cajun Seasoning, rubbing in well.
5. Bake in conventional method.

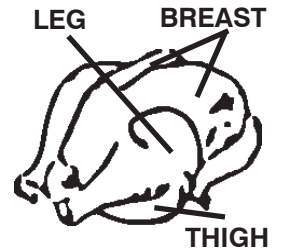

DEEP FRIED

1. Follow steps 1-4.
5. **CAUTION:** Make sure cavity of chicken is drained of water before deep frying. Deep fry whole chicken 7 minutes per pound at 350°F (177°C).

GRILLED

1. Cut whole chicken into halves and rinse with warm water.
2. Follow steps 2-4 (DO NOT inject marinade before cutting chicken into halves.)
5. Place chicken on hot grill, turning several times during grilling.

BEEF, PORK & GAME

BAKED

1. Fill Injector with desired amount of marinade.
2. Inject marinade 1 to 2 inches apart. Inject marinade slowly while pulling needle out of meat. This gives even distribution of seasoning.
3. Pour marinade generously over the roast.
4. Cook in oven until desired temperature is reached.

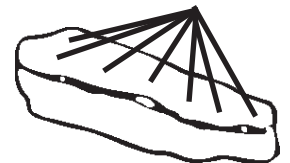

TURKEY

BAKED OR FRIED

1. Remove giblets, neck, any wires or packaging materials, and pop up timer. Rinse turkey with warm water and drain cavity completely.
2. Fill Injector with desired amount of marinade.
3. Inject FULL amounts of marinade (approximately 1 oz.) at the indicated points (breast, thigh, leg). Inject marinade slowly while pulling needle out of meat. (For best results, insert needle at different angles through the same hole when injecting marinade.)
4. Sprinkle outside of turkey generously with King Kooker® Cajun Seasoning, rubbing in well.
5. **CAUTION:** Make sure cavity of turkey is drained of water before deep frying. Deep fry turkey about 3 1/2 minutes per pound at 350°F (177°C) or bake in conventional method.

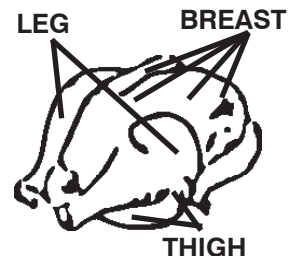

CLEANING AND STORAGE

USE SOAP AND WATER TO CLEAN INJECTOR AND ALLOW TO DRY. USE VEGETABLE OIL TO LIGHTLY COAT PLUNGER OF INJECTOR. THIS ALLOWS PLUNGER TO MOVE FREELY IN THE BARREL OF THE INJECTOR.

SECTION IV

READ AND UNDERSTAND ALL INSTRUCTIONS BEFORE USING YOUR KING KOOKER® PRODUCT

FREQUENTLY ASKED QUESTIONS AND ANSWERS

1. **What is the problem if the cooker takes too long or will not heat oil or cooking ingredients to desired temperature? My cooker's flame appearance is very weak.**

Answer: If the hose assembly has a Type 1 Connection (black/green knob), it is equipped with a flow limiting device. This device is intended to limit the flow of gas should there be a leak between the regulator and the appliance. To achieve a positive gas seal, which will allow for maximum gas flow, the regulator control must be set to a completely OFF position before the cylinder valve is opened. A good tip to remember is "TANK IS FIRST ON, LAST OFF."

The Problem Can Be Remedied by completing the following steps:

1. Turn the regulator control to the OFF position. Close the tank valve completely by turning it clockwise until it stops.
 2. Remove Type 1 Connection (black/green knob) from the tank valve. The flow limiting device will now reset.
 3. Re-attach Type 1 Connection (black/green knob) to the tank valve. Tighten completely.
 4. Turn tank valve ON (counterclockwise).
 5. Turn the regulator control to an ON position.
 6. Relight cooker following all lighting instructions contained in this manual. Check for proper flame characteristics.
2. **What is the problem if the cooker shuts off before the planned cooking time is finished?**

Answer: Your cooker has been equipped with a battery operated timer located on the hose/regulator. This timer and the supplied thermometer are not a substitute for attending a cooker. The timer is not a replacement for proper monitoring and will not measure or control the temperature of the cooking liquid within the pot. If the timer completes a 15 minute cycle without being reset, the gas flow will be turned off and the flame extinguished. Re-light according to the directions in this manual. The timer can be reset manually throughout the cooking process without shutting off the gas flow by pressing the red "START" button. Pushing the "START" button at any point when the timer is powered on will give you 15 minutes of operation. NEVER reset the timer without first reading the thermometer temperature. If the timer does not work or stops before a 15 minute operational cycle is finished, replace the batteries according to the "**Battery Installation**" instructions. Complete "**Lighting and Operating Instructions**" are shown on page 16 of the Use and Care Manual.

3. **How long will the propane in my tank last?**

Answer: On average, a full tank will give you 4 to 5 hours of normal cooking.

4. **I have a new style tank and it won't connect to my regulator. What do I do?**

Answer: The regulator supplied with this appliance has a Type 1 Connection which will attach to the tank valve which has large threads on the valve outlet. These connect into the large plastic handnut (black or green). This tank will also connect to earlier models of Metal Fusion cooker regulators which had a brass plug connector with left hand threads, which will connect to the internal threads of the Type 1 tank valve (with a wrench). If your tank has a quick disconnect valve (plug in type) our regulators can not connect to this tank.

5. **I have a brand new cooker and I cannot get the burner to light. What's the problem?**

Answer: Make sure the tank has been filled with propane. Tanks purchased from the store shelf are most often sold empty. If this does not solve the problem refer to Maintenance Instruction items #3 and #4, page 18. If you have questions please call Metal Fusion, Inc. at (800) 783-3885.

**IF YOU HAVE A QUESTION WE HAVE NOT ADDRESSED IN THIS MANUAL
PLEASE SEND US AN E-MAIL AT info@kingkooker.com OR CALL 1-800-783-3885
BETWEEN 7:30 A.M. AND 3:30 P.M. CST MONDAY THROUGH FRIDAY.**

Outdoor Cooker Safety Precautions



WARNING!

FAILURE TO FOLLOW THESE INSTRUCTIONS AND WARNINGS COULD RESULT IN FIRE, EXPLOSION, BURN HAZARD OR CARBON MONOXIDE POISONING WHICH COULD CAUSE PROPERTY DAMAGE, PERSONAL INJURY OR DEATH.

Read and understand the entire Assembly Instructions and Use and Care Manual before using this product. If you lose your manual and need a replacement, or have questions, please contact us at 1-800-783-3885 between the hours of 7:30 A.M. and 3:30 P.M. CST Monday-Friday, or go to www.kingkooker.com

WARNING: This product can expose you to chemicals including lead, known to the State of California to cause cancer, birth defects, or other reproductive harm. For more information go to www.P65Warnings.ca.gov/product



USE ONLY OUTDOORS!



DO NOT use under any overhang or roof. Keep a minimum clearance of 10 ft. (3.05m) on all sides of the cooker.



DO NOT use on combustible surfaces.



ALWAYS keep children, pets and any unauthorized persons away from cooker.



ALWAYS use a deep fry thermometer to monitor the temperature of the grease while frying and preheating.



NEVER LEAVE COOKER UNATTENDED while in use or still hot.



ALWAYS wear shoes while cooking. Keep hair and clothing from coming into contact with the cooker while in use or still hot.



ALWAYS wear protective mitts and use extreme caution not to splash hot oil.



NEVER cover the pot while frying or preheating.



ALWAYS turn the burner **OFF** when cooking is completed.



ALWAYS thaw and dry food completely before cooking with oil or grease.

KING GRILLERDINE[®], KING KOOKER[®], the KING KOOKER[®] logo, THE KING[®], THE KING OF OUTDOOR COOKING[®], MR. OUTDOORS[®], and WATCHDOG OUTDOOR COOKER SERIES[®] are trademarks of Metal Fusion, Inc., 712 St. George Avenue, Jefferson, LA 70121